

User Manual for Amazfit GTR 2 (English Edition)

Contents

User Manual for Amazfit GTR 2 (English Edition)	1
Getting started.....	3
Appearance	3
Power on and off	3
Charging	3
Wearing & Replacing Watch Strap	4
Connecting & Pairing	4
Updating the system of your watch	5
Control center	6
Time System.....	6
Units	6
Common operations.....	6
Functions available when the watch is connected to the phone.....	8
App alerts.....	8
Call	8
Find Mobile	9
Find Watch	9
Watch Face	10
Watch Face Compilations.....	10
Always On Display.....	10
Add Watch Faces.....	11
Change Watch Faces	11
Delete Watch Faces	11
Shortcuts	12
Smart Assistant.....	12
Quick Access Apps.....	12
Press the lower button.....	12
Workout.....	13
Workout.....	13
Workout GPS Positioning	13
Workout Reminders & Settings.....	14
Workout Control.....	16

Viewing workout records	17
Activities and Health	18
PAI.....	18
Activity Goal	18
Idle Alerts	19
Heart Rate.....	19
Heart Rate Alerts	19
Automatic Heart Rate Detection	Error! Bookmark not defined.
Manual measurement.....	20
Sleep	20
Sleep Assistant	21
Sleep Breathing Quality Monitoring	21
SpO ₂	21
Precautions for SpO ₂ Measurement.....	21
Stress	22
Voice Function	24
Offline Voice.....	24
Multimedia Function	26
Music	26
Watch Apps	28
Watch Apps	28
App List.....	28
Events	Error! Bookmark not defined.
Weather.....	29
Compass	29
Barometric Altimeter.....	30
Alarm.....	30
Timer	30
Countdown	31
Watch Settings.....	32
Bluetooth Settings	32
System Language Settings.....	32

Getting started

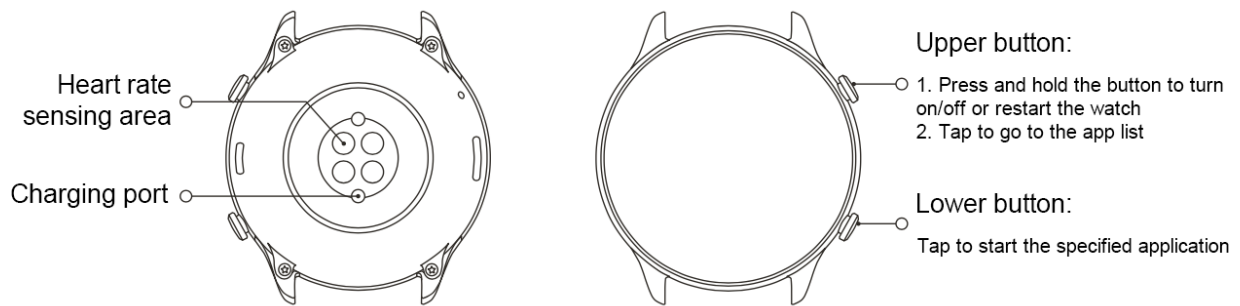

Appearance

Power on and off

Power on:

Press and hold the upper button to turn on the screen and go to the start screen. If turning on the watch by long pressing the upper button doesn't work, charge the watch and try again.

Shut down:

When the device is on, press and hold the upper button for 5 sec to go to the power menu to shut down or restart the watch.

Force shut down:

When the device is on, press and hold the upper button for 10 sec to restart the watch.

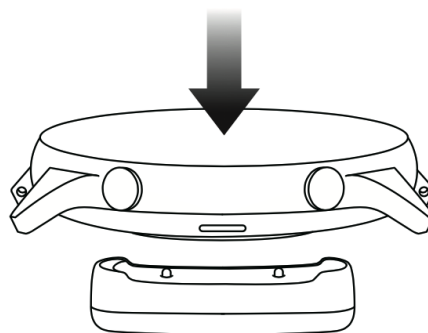

Charging

This product charges via a magnetic charging base. Please use the included charging base. Align the charging port on the back of the watch with the metal contacts on the charging base, and wait until the charging level indicator appears on the watch screen.

Note:

Use the original charging base and ensure the charging port is dry.

Use a computer USB port or a charger with a rated output voltage of 5V and a rated output current above 1A to charge your watch.

Wearing & Replacing Watch Strap

Put the strap on with comfortable looseness to allow the skin to breathe and the sensor to function.

When measuring SpO₂, avoid wearing the watch on the wrist joint, keep your arm flat, maintain a comfortable (appropriately tight) fit between the watch and the skin of your wrist, and keep your arm still throughout the measurement process. When affected by external factors (such as arm sag, arm sway, arm hair, and tattoo), measurement results may be inaccurate or the measurement may fail with no output.

You can tighten the watch strap during workout and loosen it afterwards. Tighten the strap appropriately if your watch sways on your wrist or fails to output data.

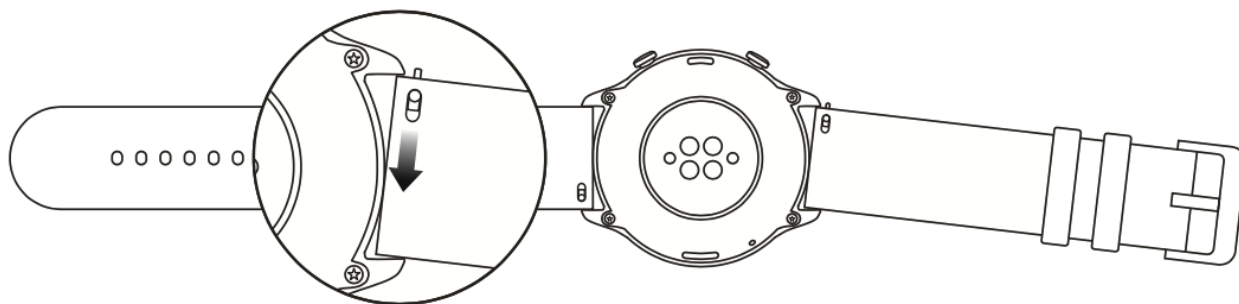

To change the watch strap, refer to the illustration below:

Note:

After the strap is attached, please pull the strap using appropriate force to ensure a secure attachment.

Avoid contact with liquid, as the leather strap is not waterproof. Switch to a fluororubber strap or a silicone strap when you cannot avoid such contact, for example, when swimming.

Connecting & Pairing

Use your phone to scan the following QR code, and download and install the Zepp app. For the best user experience, update the app to the latest version as prompted.

Note: Your mobile phone must run Android 5.0 or iOS 10.0 or later.



Initial pairing:

When the watch is started for the first time, the QR code used for pairing is displayed on the screen.

On your phone, start and log in to the Zepp app and scan the QR code displayed on the watch to pair your phone with the watch.



Pairing with a new phone:

1. On your old phone, start the Zepp app and synchronize data with the watch.
2. On your old phone, go to the information page of the watch, tap Unpair at the bottom of the page, and unpair the old phone from the watch.
3. Restore the factory settings of the watch, and restart the watch. After the watch is restarted, pair the watch with your new phone according to the initial pairing procedure.

Updating the system of your watch

Keep the watch connected with your phone, start the Zepp app, and select Profile > Amazfit GTR 2. Tap System updates to view or update the system of your watch.

It is recommended that you tap Update Immediately when your watch receives a system update message.

Control center

On the watch face page, swipe down to go to the control center for the following system functions: Flashlight, Brightness adjustment, DND, Battery saver mode, Screen locked, Find mobile, Volume setting, Theater mode, and Keep Watch Awake.

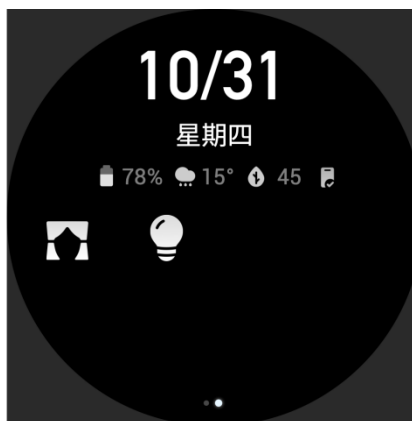

Time System

Keep the watch connected with your phone. During data synchronization, the watch automatically follows the system time and time format of your phone, and displays the time in a 12 h or 24 h format.

Units

Keep the watch connected with your phone, start the Zepp app, and go to Profile > Settings. Here, you can set the unit of measurement for distance and weight. During data synchronization, the watch automatically follows the settings in the app.

Common operations

Tap the screen	To enable this function, select the current item, or proceed with the next step.
Press and hold the watch face	to activate Watch face selection and Watch face settings
Cover the screen	Turn off the screen
Swipe up, down, left, or right	Scroll on the page or switch pages. On some pages, you can swipe right to return to the upper-level page
Press the upper button	Wake up the watch, and go to the app list or return to the watch face

Press the lower button

Start a particular app

Press and hold the upper button for 5 sec or longer

Power on the watch, go to the power page, and force restart

Functions available when the watch is connected to the phone

App alerts

Keep the watch connected with your phone to receive phone app alerts on your watch. You can swipe up on the



watch face page to view the latest 20 alerts in the Notification Center.

Setting method:

Keep the watch connected with your phone, start the Zepp app, and go to Profile > Amazfit GTR 2 > Notifications and Reminders > App alerts. Here, you can select apps for which the app alerts function needs to be enabled.

Note:

To enable this function on an Android phone, you need to add the Zepp app to the whitelist or auto-run list in the phone background so that the app always runs in the background. If the Zepp app is killed by the phone's background process, the watch will be disconnected from your phone, and you cannot receive app alerts on the watch.

Call



Pair the watch with your phone via Bluetooth and maintain the connection to receive calls on the watch.

Setting method:

Method one: Start the Zepp app and go to "Profile > Amazfit GTR 2 > App settings". On the Phone page, turn on "Call on watch", then pair the watch and your phone through Bluetooth as instructed.

Method two: On the watch and your phone, go to "Settings > Bluetooth to pair them:

1. On your phone, go to Settings, then select "Bluetooth" to turn on the Bluetooth, and set the phone to be discoverable. On the watch, go to App list > Settings > Network and connections > Bluetooth. Ensure the Bluetooth is turned on.

2. Find the watch in the search results for available devices on your phone, and tap to pair them. Or, find your phone in the Bluetooth search results on the watch, and tap to pair the devices.

Find Mobile

1. Keep the watch connected with your phone.
2. On the watch face page, swipe down to go to the control center, and tap Find mobile. Your phone will vibrate and ring.
3. In App list, select Widgets, and tap Find mobile. Your phone will vibrate and ring.

Find Watch

Keep the watch connected with your phone, start the Zepp app, and choose Profile > Amazfit GTR 2 > Find watch, after which your watch will vibrate.

Watch Face

Watch Face Complications

Some watch faces support complications. With the complications, you can view information such as steps, consumption, and weather, or tap a complication to launch the corresponding app. You can also edit information as needed.

Edit watch face complications:

1. Wake up the watch face, and press and hold the watch face page to go to the watch face selection page.
2. Swipe left or right to preview the watch faces available to the watch. The Edit button will be displayed at the bottom of a watch face that supports complications. You can tap this button to go to the page for editing the complications of this watch face.
3. Select the complication to be edited, and tap this complication, or swipe up or down on the screen to switch between complications.

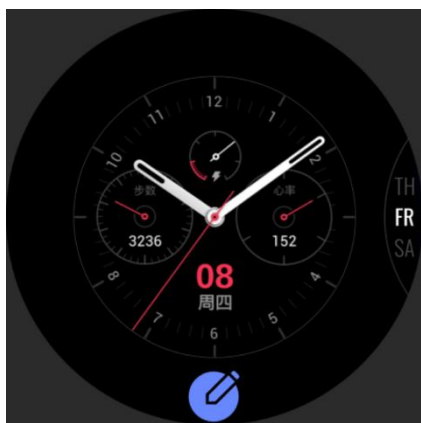
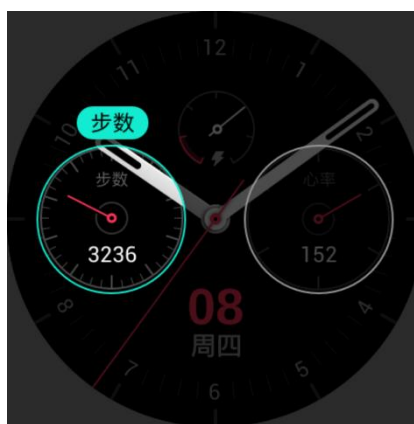

4. After editing, press the upper button to enable a watch face.

Always On Display

If this function is enabled, the screen still displays some information in standby mode, which seriously reduces battery life.

Set Always On Display:

1. Wake up the watch and press the upper button to go to the app list. Then choose Settings > Display and brightness > Always On Display.
2. Select the watch face style and enable status for Always On Display.

Add Watch Faces

In addition to the built-in watch faces, you can choose online watch faces as desired from the watch face store in the Zepp app and synchronize them to the watch. You can also set your phone images as custom watch faces with the app.

Add online watch faces:

1. Keep the watch connected with your phone, start the Zepp app, and go to Profile > Amazfit GTR 2 > Store.
2. Select one or more watch faces you wish to use, then synchronize them to the watch to give yourself multiple options.

Add customized watch faces:

Keep the watch connected with your phone, start the Zepp app, go to Profile > Amazfit GTR 2 > Store, and go to customized watch faces.

Change Watch Faces

1. Wake up the watch face, and press and hold the watch face page to go to the watch face selection page.
2. Swipe left or right to preview the watch faces available to the watch, including built-in watch faces and synchronized online watch faces.
3. Tap the desired watch face to replace the current watch face with the desired one.

Delete Watch Faces

When storage space on the watch is running out, you will need to delete some of the watch faces to make room for new ones (some built-in watch faces cannot be deleted).

1. Wake up the watch face, and press and hold the watch face page to go to the watch face selection page.
2. Swipe left or right to preview the watch faces available on the watch, including built-in watch faces, synchronized online watch faces, and customized watch faces.
3. Press and hold the watch face you want to delete, and swipe up on the screen. A delete button appears if the watch face can be deleted. Tap to delete it.

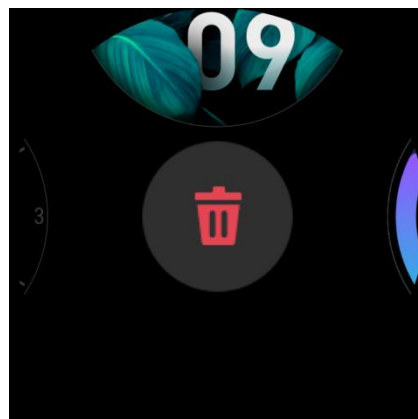

Shortcuts

Smart Assistant

Swipe right on the watch face to go to the smart assistant page, which supports the easy use and view of various functions and information:

1. View real-time app information, such as progress information such as workouts and count down, which automatically appears on the smart assistant page.
2. View information about items and resident apps, such as your next scheduled event, alarm, and recent heart rate data.

You can also start the Zepp app and go to "Profile > Amazfit GTR 2 > Smart assistant" to set the contents displayed and the order in which they are displayed.



Quick Access Apps

Quick access apps shown on the left side of the watch face offer you convenient use of watch functions. You can add your frequently used applications and functions, such as "Workout".

Change quick access apps:

1. Wake up the watch and press the upper button to go to the app list. Then go to Settings > User preferences > Quick access apps, and swipe up or down to view the applicable apps.
2. When the number of "Current apps" reaches the upper limit, remove the redundant apps and add the ones you need.

Press the lower button

Press the lower button to start a pre-configured app. The "Workout" app is opened by default. You can also replace it with an app that you frequently use on the Settings page.

Workout

Workout

The watch supports 12 workout modes, including outdoor running, walking, outdoor cycling, **treadmill**, indoor cycling, **open water swimming**, pool swimming, elliptical trainer, climbing, trail running, skiing, and free training.

Wake up the watch, press the upper button to go to the app list, select Workout, and tap the workout mode you desire. Then tap GO on the workout preparation page to start recording workout information.

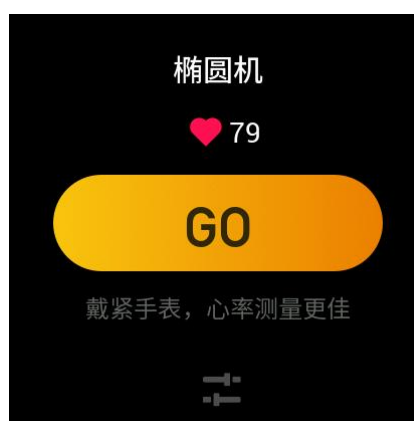

Workout GPS Positioning

If you do outdoor exercise, wait on the workout preparation page until GPS positioning is successful. Then tap GO to start workout. This helps avoid tracking loss to guarantee complete and accurate workout data recording.

Positioning guide:

1. If you receive a prompt to update the AGPS after selecting an exercise, start the Zepp app on your phone and connect it with the watch to update AGPS. Then, select an exercise again. This operation reduces the time spent searching for a signal and avoids search failure.
2. During the positioning process, the GPS signal icon continues to flicker. And an open area can offer you faster positioning for better GPS signal, as nearby buildings may block and weaken the signal, extending the positioning time and even causing positioning failure.
3. After successful positioning, the GO button is highlighted. The GPS signal shows the current GPS signal strength.



AGPS (Assisted GPS) is a kind of GPS satellite orbit information data which helps the watch accelerate the GPS positioning process.

Workout Reminders & Settings

At the bottom of the workout preparation page, you can tap the "Settings" icon to set the current workout mode. The related parameters vary depending on the workout mode.

Workout goal:

You can set goal reminders for the target distance, target time, and target consumption.

Workout reminder:

You can set reminders for distance, safe heart rate, heart rate zone, pace, and speed.

Auto pause:

The watch automatically detects the workout status. When it detects that the workout has stopped, the watch automatically stops recording information about the current workout. When it detects that the workout has started again, the watch continues to record.

Real-time graph:

You can set the watch to display a real-time graph of the heart rate, pace, speed, and pull speed rate during your workout.

Length of swimming lane:

You can set the length of swimming lane during pool swimming to record swimming distance.

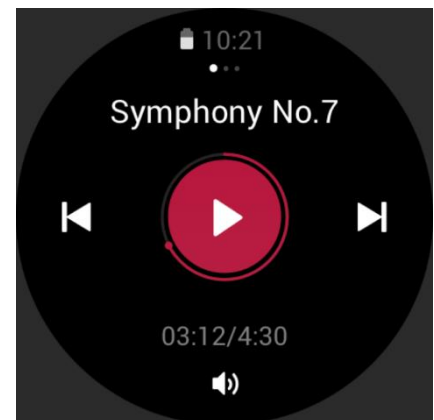

Workout Control

Enable the workout app to run in the background:

1. To use other functions during your workout, press the upper button to return to the watch face page for other operations. The workout app will continue running in the background.
2. When the workout app continues running in the background, the watch will continuously record workout data and generate reminders based on the workout settings.
3. When the workout app is launched again, the watch automatically goes to the ongoing workout.

Play music:

Swipe left on the screen to control music playback on the watch apps or phone apps during your workout.

View data:

During a workout, you can swipe up or down on the screen to view different data.

Control workout:

Swipe right on the screen to pause or continue workout, end workout and lock the screen.

Save workout data:

When you stop a workout, the workout data is not saved if the distance is too short or the workout time is too short. Due to limited storage space, it is recommended that you synchronize the workout data to the Zepp app soon after completing a workout. Otherwise, the workout data may be overwritten.

Viewing workout records

View workout records on the watch:

Wake up the watch, press the upper button to go to the app list, and select Activities to view the latest 30 workout records. You can also select a record and view its details.

View workout records on the phone:

Synchronize the workout data to the Zepp app on the phone and view the detailed workout records on the workout record page.



Activities and Health

PAI

PAI is an indicator of personal physiological activity. Based on heart rate data, daily activity intensity, and multi-dimensional and dynamic evaluation of personal physiological data, PAI is obtained through calculations by an algorithm. PAI does not rely on individual data categories alone. Therefore, it allows you to systematically and comprehensively understand your physical condition.

By maintaining a certain intensity of daily activities or workouts, you can obtain your PAI value. According to the results of the HUNT Fitness Study*, maintaining a PAI above 100 helps reduce the risk of cardiovascular death and increase life expectancy.

For more information, start the Zepp App and choose PAI cards > Q&A.



*The HUNT Fitness Study, a sub-project of the HUNT study, is led by Professor Ulrik Wisloff from Medical School of Norwegian University of Science and Technology. It has lasted for over 35 years, and involved more than 230,000 participants.

Activity Goal

The watch automatically records your activity data, including steps, calories, standing count, and distance. It also records the duration that heart rate is maintained within or above the fat-burning range as an index of fat-burning time.

1. Your daily activity goal consists of three parts, including Move ring (with target steps or calories), Fat burning ring, and Stand ring.

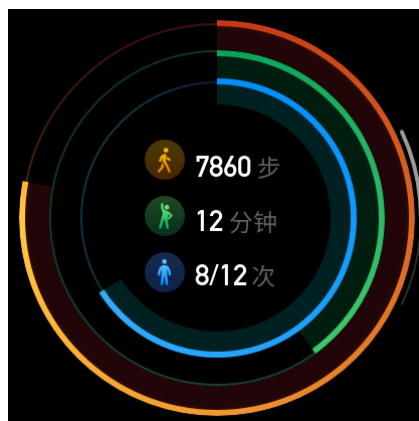

2. When a target is achieved, the watch vibrates to congratulate you.

Idle Alerts

To encourage you to have a certain amount of activity every hour when you are awake and reduce the harm caused by sitting for too long, the watch monitors your activity as you wear it.

If no activity is detected for more than 1 min at the 50th min of the current hour when you are properly wearing the watch, the watch will vibrate to remind you to do some exercise. After receiving an idle-alert, if you complete activities before the next hour arrives, the stand target of the current hour can still be achieved.

Enabling idle alerts:

Keep the watch connected with your phone, start the Zepp app, choose Profile > Amazfit GTR 2 > [Notifications and reminders](#) > Idle alert, and enable the function.

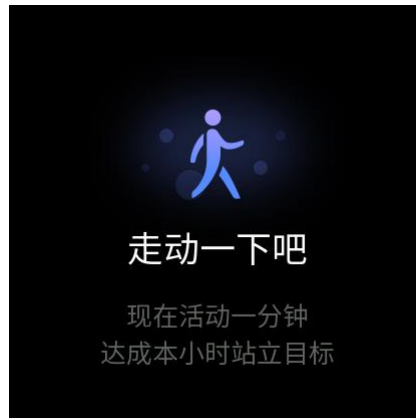

Heart Rate

Heart rate is an important indicator of physical condition. Highly-frequent heart rate measurement helps capture more heart rate changes and provide a reference for a healthy lifestyle.

To ensure measurement accuracy, you need to wear the watch correctly according to the instructions, and ensure that the part next to your skin is clean and free of sunscreen smear.

Heart Rate Alerts

You can enable the heart rate alert function, when you set the detection interval as within 10 minutes.



The watch vibrates when the alert value is reached and there is no obvious activity detected in the last 10 min.

Automatic Heart Rate Detection

1. Keep the watch connected with your phone, start the Zepp app, choose Profile > Amazfit GTR 2 > [Health Monitoring](#) to enable [Automatic heart rate detection](#) and set measuring frequency. Then the watch

automatically conducts regular measurement of your heart rate at the set frequency and records your heart rate change throughout the day.

2. Heart rate can change dramatically when you are doing an activity. If you enable the **Activity detection** function, the watch will automatically increase the heart rate detection frequency to guarantee the accuracy of HR data during workouts.
3. The watch's heart rate app allows you to view the heart rate curve and heart rate distribution throughout the day.

Manual measurement

1. To measure your heart rate manually when **Automatic heart rate detection** is not enabled, wake up the watch, press the side button to go to the app list, and swipe up or down to select the heart rate app.
2. You can set the heart rate app as a quick access app to facilitate heart rate measurement.

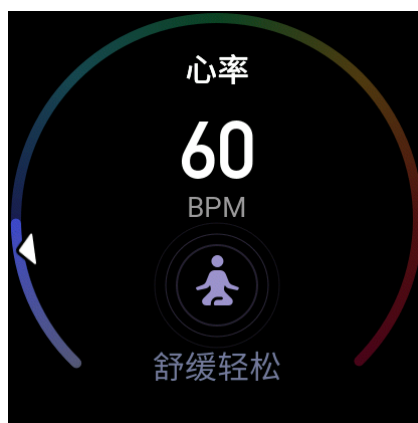
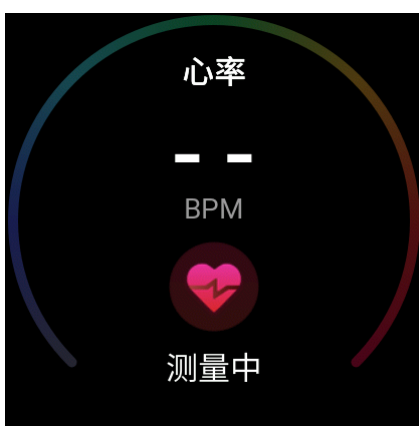

3. The watch only allows you to view the heart rate value measured this time. To view historical records, you need to synchronize data to the Zepp app.

Sleep

Sleep quality has an important impact on human health.

If you wear the watch while sleeping, it automatically records sleep information. You can synchronize sleep information to the Zepp app to view the sleep time, sleep stages, sleep score, and sleep suggestions.

Sleep Assistant

Keep the watch connected with your phone, start the Zepp app, and go to Profile > Amazfit GTR 2 > Health Monitoring to enable Sleep assistant for more accurate sleep information (REM sleep stage).

Sleep Breathing Quality Monitoring

Keep the watch connected with your phone, start the Zepp app, and go to Profile > Amazfit GTR 2 > Health Monitoring to enable sleep breathing quality monitoring. Then, the watch will automatically monitor sleep breathing quality when it detects that you wear the device during sleep.

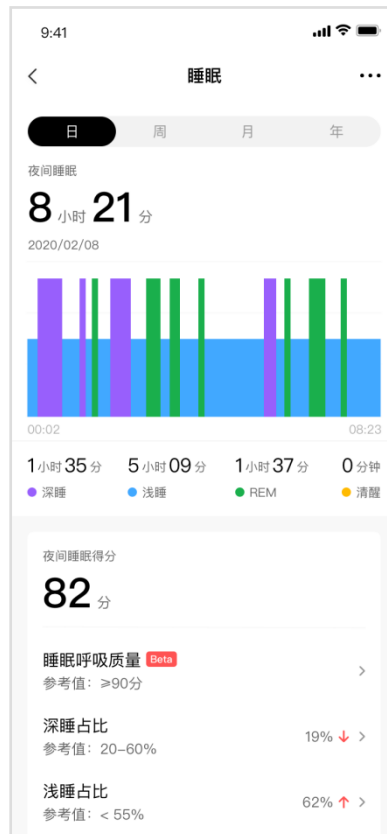

SpO₂

Blood oxygen saturation (SpO₂) is an important physiological parameter of respiration and circulation.

1. Wake up the watch, press the upper button to go to the app list, and select the SpO₂ app to start measuring SpO₂.
2. When you are climbing a mountain, you can run the Workout app in the background, and start the SpO₂ app to measure SpO₂.
3. After measurement is complete, the result will be displayed on the watch. You can also view measurement results for the whole day.

Precautions for SpO₂ Measurement

1. Wear the watch a distance of one finger away from the carpal and remain still.
2. Wear the band tightly, with an appropriate sense of pressure.

3. Place your arm on a tabletop or a stationary surface, with the watch screen facing up.
4. Remain still during measurement and focus on the measurement.
5. Factors such as hair, tattoo, shaking, low temperature, and incorrect wearing of the watch may affect measurement results, and even lead to measurement failure.
6. The measurement range of this watch is 80%-100%. This function is for reference only and should not be used as the basis for medical diagnosis. If you feel unwell, please seek professional medical advice.

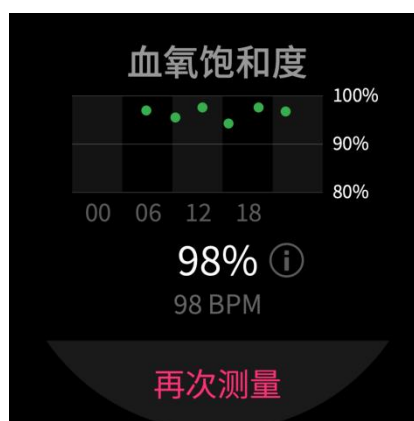
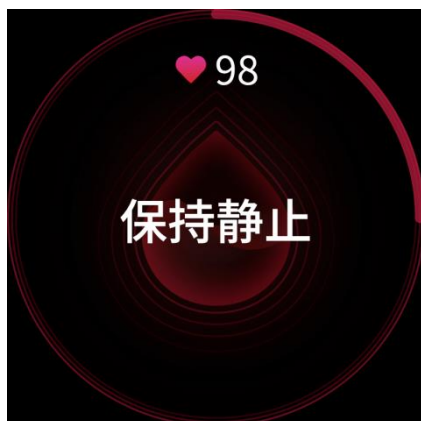

Stress

The stress index is calculated based on changes in heart rate variability. It is a reference for health status evaluation. You should rest more when the index is high.

1. Wake up the watch, press the upper button to go to the app list, and swipe up or down to select the stress app to view related information.
2. When Automatic stress testing is enabled in the stress app, stress measurement is performed every 5 min to show you changes in your stress. You can also keep the watch connected with your phone, start the Zepp app, and go to Profile > Amazfit GTR 2 > Health Monitoring to set this function.

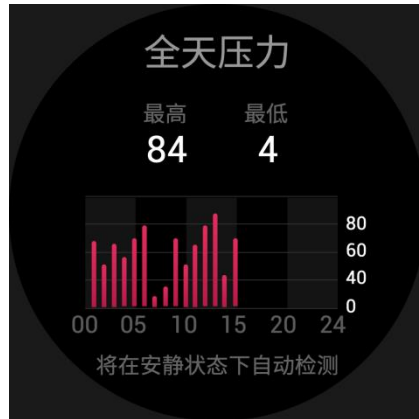

3. If Automatic stress testing is not enabled, you can access the stress app for measurement at any time and view and record the results.

Voice Function

Offline Voice

Offline voice control allows you to speak to perform most of operations on the watch without connecting to a mobile phone.

Offline voice wake up mode:

Go to Settings > User preferences > Offline voice control > Wake up mode

1. Respond in 5 sec after you turn your wrist.
2. Responds within 5 sec after the screen lights up.



3. Response during screen lighting.

Select "Respond in 5 sec after you turn your wrist" and "Responds within 5 seconds after the screen lights up" to enable Offline voice. After turning your wrist or lighting the screen, the "Recognizing offline voice" icon appears. Then you can run offline voice commands to perform related operations.



If you select "Response during screen lighting" to enable Offline voice, you can use offline voice command words directly without waiting to see the "Recognizing offline voice" icon.

Offline voice commands words:

Go to Settings > User preferences > Offline voice control > View all voice commands. Here, you can see all the offline voice command words the watch supports.

Multimedia Function

Music

Play local music:

The watch supports direct music playback, and, under Bluetooth connections, it can play music with a Bluetooth headset or stereo.

1. Add songs: Start the Zepp app and go to Profile > Amazfit GTR 2. On the Music page, select .mp3 or .wav music files to transfer from your phone to the watch. After completing the transfer, you can play music on the watch.
2. The Music page displays the name and composer of a song. It also supports switching between previous and next tracks, play/pause, setting play mode and volume adjustment operations.
3. The second Music page allows you to add songs to My Favorites, switch audio source, view the playlist, connect to Bluetooth audio devices, and more.

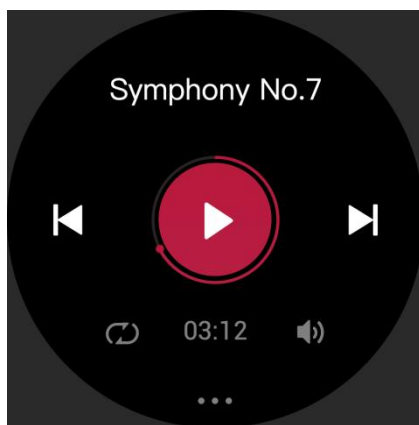

Music remote controller:

Keep the watch connected with your phone. When playing music on your phone, you can start or pause the music, switch to the previous or next song, and perform other operations on the music app of your watch.

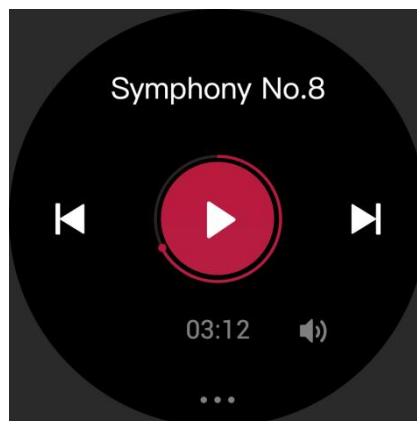

Modify settings on an Android phone:

Keep the watch connected with your phone, start the Zepp app, and go to "Profile > Amazfit GTR 2 > App List Managing". On the page that appears, tap the "Access to read notification not enabled" message to go to the Notification settings page and grant notification permissions for the Zepp app. If this message is not displayed, permission is already granted.

Note:

To enable this function on an Android phone, you need to add the Zepp app to the whitelist or auto-run list in the phone background so that the app always runs in the background. If the Zepp app is killed by the phone's background process, the watch will be disconnected from your phone and you cannot control music playback.

Watch Apps

Watch Apps

"Apps" refer to the watch functions that can be used separately, such as workout, heart rate, and weather.

To use an app, wake up the watch, press the upper button to go to the app list, swipe up or down to browse the app list, and tap an app to start it.



You can also set frequently used apps as quick access apps to facilitate your use.

App List

Keep the watch connected with your phone, start the Zepp app, and choose Profile > Amazfit GTR 2 > App list management. Then you can set the apps on the watch.

Schedule

After you create a schedule, the watch will vibrate to remind you when the scheduled reminding time arrives.

Keep the watch connected with your phone, start the Zepp app, and go to Profile > Amazfit GTR 2 > Schedule. Here, you can create or edit a schedule.

Wake up the watch, press the upper button to go to the app list, and tap Schedule to view the configured schedules. Tap Schedule to edit the date and time for reminders.

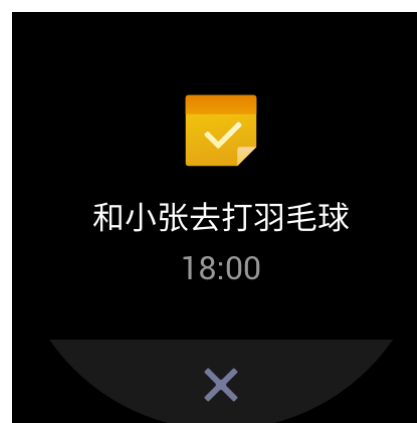

Weather

You can check today's weather, wind, humidity, UV intensity, and other information at any time, as well as the weather information for your current location for the next 7 days.

The weather data needs to be synchronized through the mobile network. Therefore, you need to keep the watch connected to your phone to keep weather information up to date.



You can set the city and temperature unit (Celsius or Fahrenheit) in the Zepp app.

Compass

Before use, you may need to draw the shape of the number 8 to complete calibration. A reminder will appear prompting you to calibrate. After you finish calibration, the watch will display the current latitude and longitude of the watch and the direction it is pointing. To avoid interference and improve accuracy, keep the watch

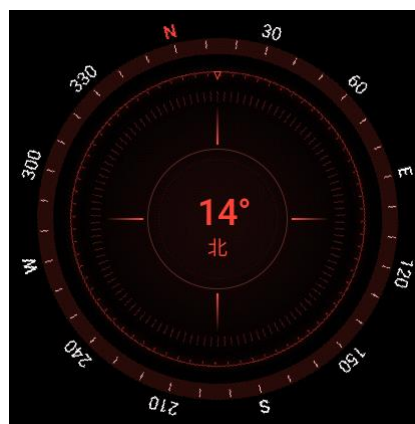

horizontal and keep it away from magnetic fields during use.

Barometric Altimeter

The barometric altimeter can show pressure and altitude information for your current position after positioning. After successful positioning, your watch displays the latitude and longitude.



Alarm

You can add alarms in the Zepp app and on the watch. Alarms can be repeated, enabled, or deleted. Long press alarms that are no longer needed to delete them.

When the preset time for an alarm arrives, the watch will vibrate as a reminder. You can choose to nap or turn it



off. If you choose to nap, it will vibrate again after 10 min. You can only use this function 5 times per alarm.

If you do nothing when the watch vibrates, it will automatically turn on nap mode after 30 sec.

Timer

The watch provides a timer with an accuracy of 0.01 sec and a maximum recording time of 24 h.

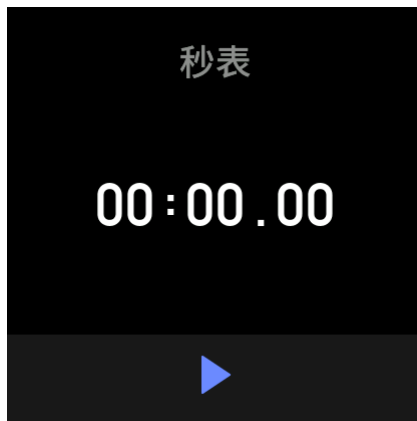
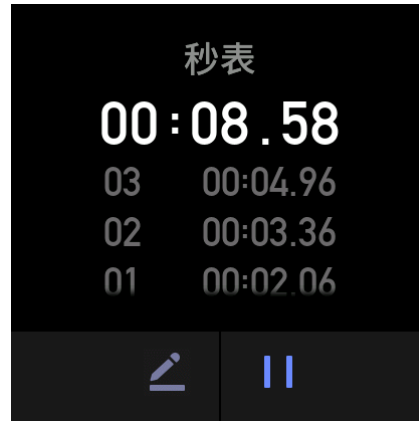

The watch can count times while timing, and can record up to 99 times.

Countdown

You can set a countdown clock. At the end of the count down, the watch will vibrate to remind you.



Watch Settings

Bluetooth Settings

On your watch, go to App List > Settings > Network and connections. On the Bluetooth page, find your Bluetooth audio device and tap Pair.



Note: If you cannot connect your watch to a paired Bluetooth device, unpair and reconnect them.

System Language Settings

Start the Zepp app, then go to Profile > Amazfit GTS 2 > Watch settings > System language to change the system language of the watch.